



DF-G2 High-Speed Expert Dual Display Fiber Amplifier Product Manual

Original Instructions

p/n: 177899 Rev G

31-Mar-26

© Banner Engineering Corp. All rights reserved. www.bannerengineering.com

Contents

Chapter 1 Product Description	3
Models	3
Overview	4
Top Panel Interface	4
Specifications	5
Excess Gain Curves	6
Beam Patterns	8
Dimensions	11
 Chapter 2 Installation Instructions	 12
Mounting Instructions	12
Mount on a DIN Rail	12
Mount to the Accessory Bracket (SA-DIN-BRACKET)	12
Remove from a DIN rail	12
Installing the Fibers in a DF-Gx Sensor	13
Fiber Adapters	13
Wiring Diagrams	14
 Chapter 3 Operating Instructions	 15
Run Mode	15
Program Mode	15
TEACH Selection	15
Response Speed	16
Offset Percent	16
Auto Thresholds	16
Delays/Timers	17
Gain Selection	17
Factory Defaults	17
Remote Input	18
Adjust Mode	19
Two-Point TEACH	19
Two-Point TEACH and Manual Adjust	19
Dynamic TEACH	20
Dynamic TEACH and Manual Adjust	20
Window SET	22
Window SET Window SET and Manual Adjust	22
Light SET	24
Light SET and Manual Adjust	24
Dark SET	25
Dark SET and Manual Adjust	25
Calibration SET	27
Calibration SET and Manual Adjust	27
 Chapter 4 Accessories	 29
Quick-Disconnect Cordsets	29
 Chapter 5 Product Support and Maintenance	 32
Troubleshooting	32
Manual Adjustments Disabled	32
Percent Minimum Difference after TEACH	32
Percent Offset after SET	32
Threshold Alert or Threshold Error	32
Banner Engineering Corp Limited Warranty	32

Chapter Contents

Models 3
 Overview 4
 Top Panel Interface 4
 Specifications 5

Chapter 1 Product Description

Advanced sensor with dual digital displays for use with plastic and glass fiber optic assemblies

- Best in class response speeds of: 10 μ s, 15 μ s, 50 μ s, 250 μ s, 500 μ s, 1000 μ s and 2000 μ s allow the operator to optimize for fast response, long distance applications, or noisy environments.
- Outstanding color contrast sensitivity; detects 32 levels of gray scale from black to white
- Choose from IR or one of 4 visible beam colors: red, blue, green and white. Depending on the beam color and fiber, the sensor reliably detects the toughest color mark contrasts
- Easy to read dual digital displays show both signal level and threshold simultaneously
- Lever action fiber clamp provides stable, reliable, and trouble-free fiber clamping
- Simple user interface ensures easy sensor set-up and programming via displays and switches/buttons or remote input teach wire
- *Expert* TEACH and SET methods ensure optimal gain and threshold for all applications, especially for high speed or low contrast applications
- User has full control over all operating parameters: threshold, Light Operate or Dark Operate, output timing functions, gain level, and response speed
- Thermally stable electronics shorten start-up time and maintain signal stability during operation
- ECO (economy) display mode reduces amplifier power consumption by 25%
- Cross talk avoidance algorithm allows two sensors to operate in close proximity for many applications
- Sleek 10 mm wide housing mounts to 35 mm DIN rail

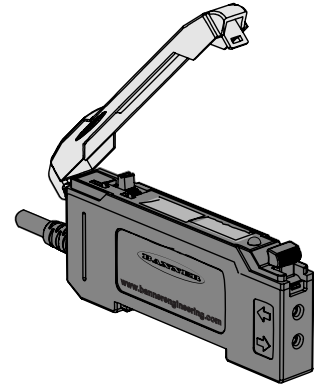

WARNING:



- **Do not use this device for personnel protection**
- Using this device for personnel protection could result in serious injury or death.
- This device does not include the self-checking redundant circuitry necessary to allow its use in personnel safety applications. A device failure or malfunction can cause either an energized (on) or de-energized (off) output condition.

Models

Model	Sensing Beam Color	Reference Sensing Range ⁽¹⁾	Outputs	Connector
DF-G2-NS-2M	Visible Red	1100 mm	Single NPN	2 m (6.5 ft) cable, 4-wire
DF-G2-PS-2M			Single PNP	
DF-G2W-NS-2M	Broad Spectrum White	550 mm	Single NPN	
DF-G2W-PS-2M			Single PNP	
DF-G2G-NS-2M	Visible Green	660 mm	Single NPN	
DF-G2G-PS-2M			Single PNP	
DF-G2B-NS-2M	Visible Blue	770 mm	Single NPN	

Continued on page 4

⁽¹⁾ Excess gain = 1, Long Range response speed, opposed mode sensing. PIT46U plastic fiber used for visible LED models, IT.83.3ST5M6 glass fiber used for IR model

Continued from page 3

Model	Sensing Beam Color	Reference Sensing Range	Outputs	Connector
DF-G2B-PS-2M	Infrared	2100 mm	Single PNP	
DF-G2IR-NS-2M			Single NPN	
DF-G2IR-PS-2M			Single PNP	

- Models with a quick disconnect require a mating cordset (see ["Quick-Disconnect Cordsets" on page 29](#))
- For 9 m cable, change the suffix 2M to **9M** in the 2 m model number (example, DF-G2-NS-**9M**)
- For 150 mm (6 in) PVC cable with a 4-pin M8 quick disconnect, change the suffix 2M to **Q3** in the 2 m model number (example, DF-G2-NS-**Q3**)
- For 150 mm (6 in) PVC cable with a 4-pin M12 quick disconnect, change the suffix 2M to **Q5** in the 2 m model number (example, DF-G2-NS-**Q5**)
- For integral 4-pin M8 quick disconnect, change the suffix 2M to **Q7** in the 2 m model number (example, DF-G2-NS-**Q7**)

The following models are no longer available for order but are still covered by the information in this document.

Model	Sensing Beam Color	Reference Sensing Range	Outputs	Connector
DF-G2-NS-9M	Visible Red	1100 mm	Single NPN	9 m cable, 4-wire
DF-G2B-NS-Q5	Visible Blue	770 mm	Single NPN	150 mm cable with a 4-pin M12 quick disconnect connector
DF-G2IR-NS-Q5	Infrared	2100 mm	Single NPN	
DF-G2W-NS-Q5	Broad Spectrum White	550 mm	Single NPN	9 m cable, 4-wire
DF-G2W-PS-2M	Broad Spectrum White	550 mm	Single PNP	

Overview

The DF-G2 is an easy-to-use, DIN-rail-mountable fiber optic sensor with best-in-class response speed and repeatability. It provides high-performance sensing in high-speed or low-contrast applications where fast response time is required.

The sensor's compact housing has dual digital displays (Red/Green) and a bright output LED for easy programming and status monitoring during operation. The sensor features a single discrete output, either NPN or PNP, by model.

The DF-G2 features improved temperature compensation compared with previous fiber optic sensors. An accessory clamp is available to secure a bank of connected sensors together on a DIN rail (see ["Accessories" on page 29](#)).

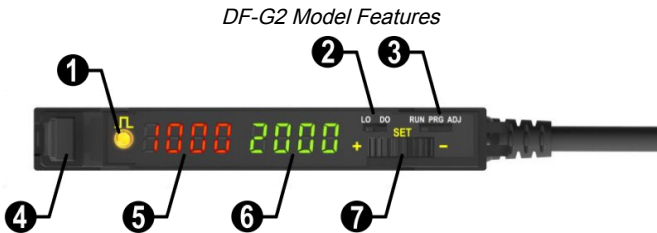

1	Output LED
2	LO/DO Switch
3	RUN/PRG/ADJ Mode Switch
4	Lever Action Fiber Clamp
5	Red Signal Level
6	Green Threshold
7	+ / SET / - Rocker Button

Top Panel Interface

Opening the dust cover provides access to the top panel interface. The top panel interface consists of the RUN/PRG/ADJ mode switch, LO/DO switch, +/SET/- rocker button, dual red/green digital displays, and output LED.

RUN/PRG/ADJ Mode Switch



The RUN/PRG/ADJ mode switch puts the sensor in RUN, PRG (Program), or ADJ (Adjust) mode. RUN mode allows the sensor to operate normally and prevents unintentional programming changes via the +/-SET/- button. PRG mode allows the sensor to be programmed through the display-driven programming menu (see ["Program Mode" on page 15](#)). ADJ mode allows the user to perform Expert TEACH/SET methods and Manual Adjust (see ["Adjust Mode" on page 19](#)).

LO/DO Switch



The LO/DO switch is used to select Light Operate or Dark Operate mode. In Light Operate mode, the output is ON when the sensing condition is above the threshold (for Window SET, the output is ON when the sensing condition is inside the window). In Dark Operate mode, the output is ON when the sensing condition is below the threshold (for Window SET, the output is ON when the sensing condition is outside the window).

+ /SET/- Rocker Button

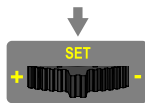

The +/SET/- rocker button is a 3-way button. The +/- positions are engaged by rocking the button left/right. The SET position is engaged by clicking down the button while the rocker is in the middle position. All three button positions are used during PRG mode to navigate the display-driven programming menu. During ADJ mode, SET is used to perform TEACH/SET methods and +/- are used to manually adjust the threshold(s). The rocker button is disabled during RUN mode, except when using Window SET, see ["Window SET" on page 22](#).

Red/Green Digital Displays



During RUN and ADJ mode, the Red display shows the signal level and the Green display shows the threshold. During PRG mode, both displays are used to navigate the display-driven programming menu.

Output LED

The output LED provides a visible indication when the output is activated.

Specifications

Sensing Beam

- DF-G2: Visible red, 635 nm
- DF-G2W: Broad spectrum white, 450 nm to 650 nm
- DF-G2B: Visible blue, 470 nm
- DF-G2G: Visible green, 525 nm
- DF-G2IR: Infrared, 850 nm

Supply Voltage

10 V DC to 30 V DC Class 2 (10% maximum ripple)

Power and Current Consumption (exclusive of load)

Standard display mode: 960 mW, Current consumption < 40 mA at 24 V DC

ECO display mode: 720 mW, Current consumption < 30 mA at 24 V DC

Supply Protection Circuitry

Protected against reverse polarity and transient overvoltages

Delay at Power-Up

500 milliseconds maximum; outputs do not conduct during this time

Output Configuration

1 NPN or 1 PNP output, depending on model

Output Rating

- 100 mA maximum load (derate 1 mA per °C above 30 °C)
- OFF-state leakage current:** < 5 µA at 30 V DC;
- ON-state saturation voltage:** NPN: < 1.5 V; PNP : < 2 V

Output Response Time

- Super High Speed: 10 µs
- High Speed: 15 µs
- Fast: 50 µs
- Standard: 250 µs
- Medium Range: 500 µs
- Long Range: 1000 µs
- Long Range with immunity to Energy Efficient Lights: 2000 µs

Repeatability

- Super High Speed: 5 µs
- High Speed: 5 µs
- Fast: 12 µs
- Standard: 50 µs
- Medium Range: 80 µs
- Long Range: 165 µs
- Long Range with immunity to Energy Efficient Lights: 165 µs

Indicators

Red 4-digit Display: Signal Level

Green 4-digit Display: Threshold

(In Program Mode, Red and Green displays are used for programming menus)

Yellow LED: Output conducting

Construction

Black ABS/polycarbonate alloy (UL94 V-0 rated) housing, clear polycarbonate cover

Connections

PVC-jacketed 2 m or 9 m (6.5 ft. or 30 ft.) 4-wire integral cable; or integral 4-pin M8 quick disconnect; or 150 mm (6 in.) cable with a 4-pin M12 quick disconnect; or 150 mm (6 in.) cable with a 4-pin M8 quick disconnect.

Output Protection

Protected against output short-circuit, continuous overload, transient overvoltages, and false pulse on power-up

Environmental Rating

IP50, NEMA 1

Operating Conditions

Temperature: -10 °C to +55 °C (+14 °F to +131 °F)

Storage Temperature: -20 °C to +85 °C (-4 °F to +185 °F)

Humidity: 90% at +60 °C maximum relative humidity (non-condensing)

Adjustments

3-way RUN/PRG/ADJ Mode Switch

2-way LO/DO Switch

3-way +/-SET/- Rocker Button

- Expert-style teaching (Two-Point and Dynamic TEACH, Light/Dark/Window/Calibration SET)
- Manually adjust sensitivity (from "+" and "-" rocker button only)
- Response Speed, TEACH Selection, Offset Percent, Auto Thresholds, Delays/Timers, Display Readout, Gain Selection, Factory Defaults (from top panel or remote input)
- Top panel interface lockout (from remote input only)

Factory Default Settings

Setting	Factory Default
Threshold	2011
TEACH Selection	Two-Point TEACH
Response Speed	Standard: 250 μs
Offset Percent	10%
Auto Thresholds	OFF
OFF Delay	0 (Disabled)
OFF One-Shot	0 (Disabled)
ON Delay	0 (Disabled)
ON One-Shot	0 (Disabled)
Display Readout	Numeric, ECO disabled, Normal Orientation
Gain Selection	Auto Gain

Certifications

 Banner Engineering BV
Park Lane, Culliganlaan 2F bus 3
1831 Diegem, BELGIUM

 Turck Banner LTD Blenheim House
Blenheim Court
Wickford, Essex SS11 8YT
GREAT BRITAIN

 Industrial Control Equipment
3TJJ

Required Overcurrent Protection



WARNING: Electrical connections must be made by qualified personnel in accordance with local and national electrical codes and regulations.

Overcurrent protection is required to be provided by end product application per the supplied table.

Overcurrent protection may be provided with external fusing or via Current Limiting, Class 2 Power Supply.

Supply wiring leads < 24 AWG shall not be spliced.

For additional product support, go to www.bannerengineering.com.

Supply Wiring (AWG)	Required Overcurrent Protection (A)	Supply Wiring (AWG)	Required Overcurrent Protection (A)
20	5.0	26	1.0
22	3.0	28	0.8
24	2.0	30	0.5

Excess Gain Curves

The excess gain curves shown are for the standard red LED emitter models. Multiplication factors for the other colored LEDs (with respect to the red LED values) are:

- White 0.5
- Green 0.6
- Blue 0.7
- IR850—see IR850 excess gain curves

The data in the charts labeled for the Long Range application apply to both the 1000 μ s and 2000 μ s response speeds.

PIT16U-Opposed Mode

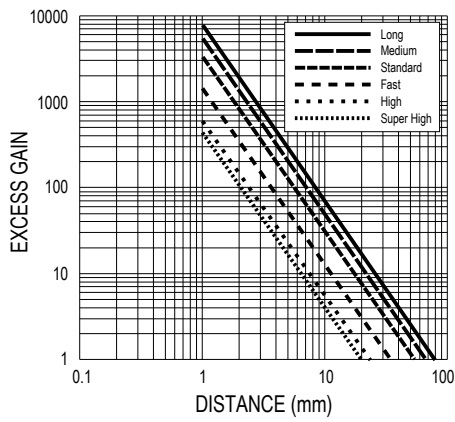

PBT16U-Diffuse Mode

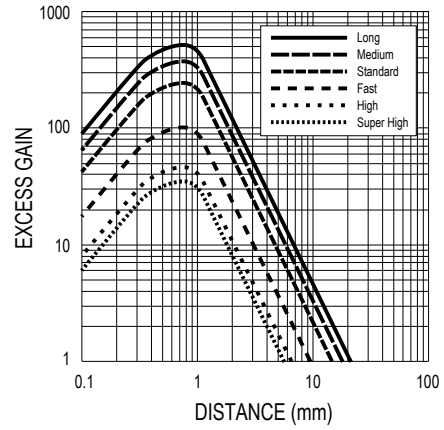

PIT26U-Opposed Mode

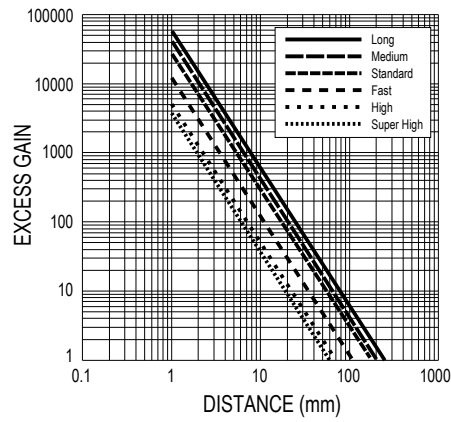

PBT26U-Diffuse Mode

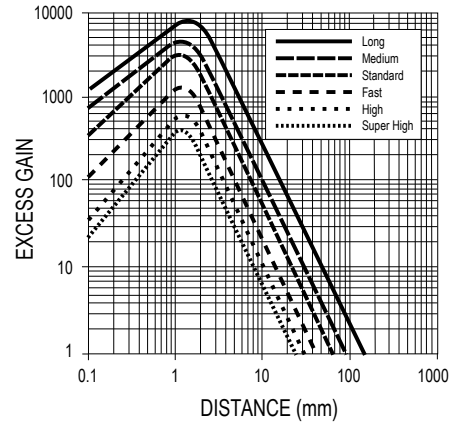

PIT46U-Opposed Mode

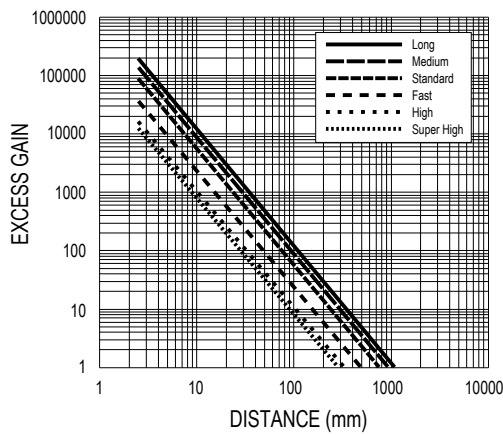

PBT46U-Diffuse Mode

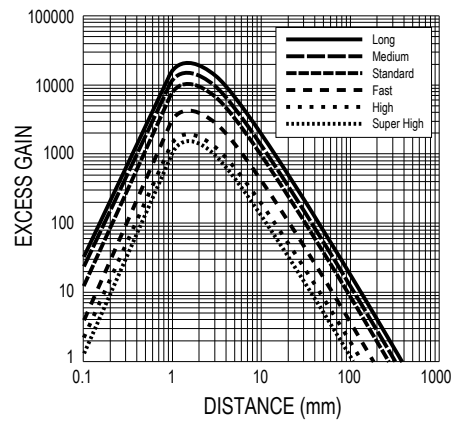

Continued on page 8

Continued from page 7

PIT66U-Opposed Mode

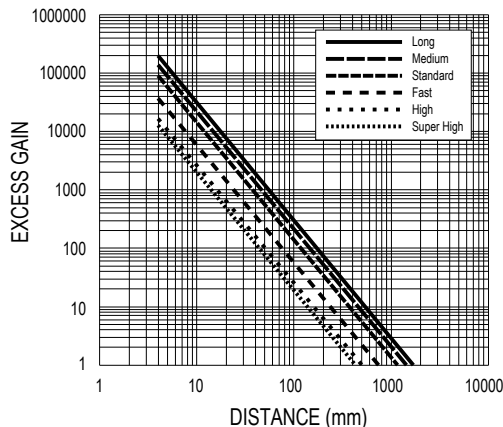

PBT66U-Diffuse Mode

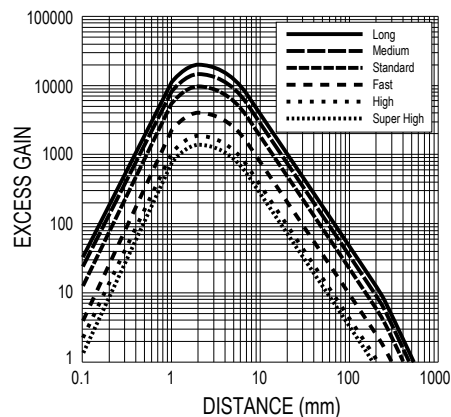

IR850-Opposed Mode

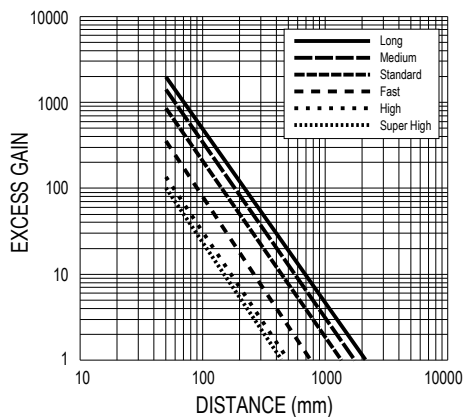

IR850-Diffuse Mode

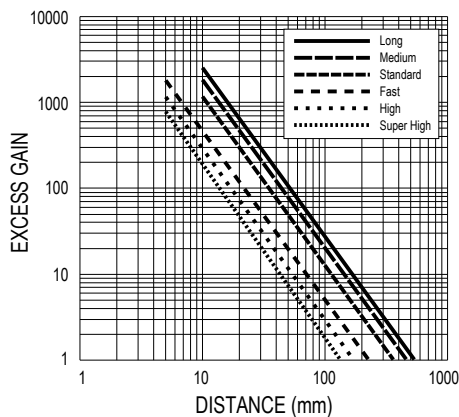

NOTE: IT.83.3ST5M6 glass fiber used for opposed mode

NOTE: BTC1.13.4ST5M6 glass fiber used for diffuse mode

Beam Patterns

The beam patterns shown are for the standard red LED emitter models. Multiplication factors for the other colored LEDs (with respect to the red LED values) are:

- White 0.5
- Green 0.6
- Blue 0.7
- IR850—see the IR850 beam patterns

The data in the charts labeled for the Long Range application apply to both the 1000 μ s and 2000 μ s response speeds.

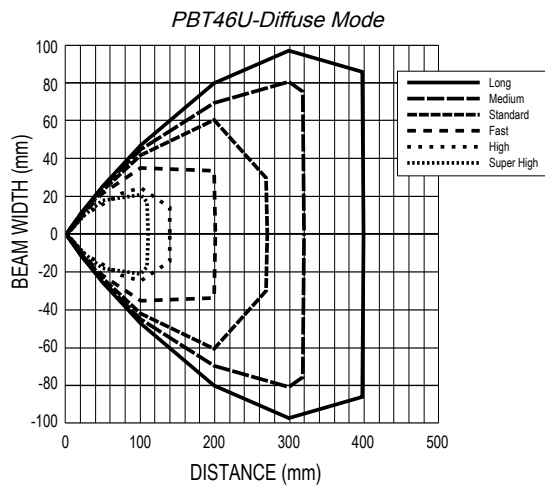
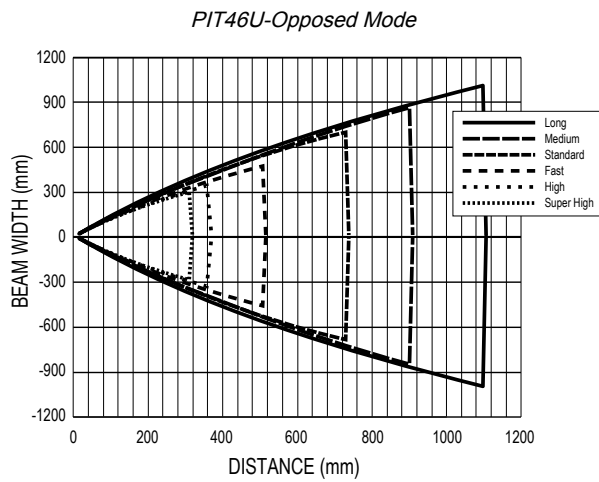
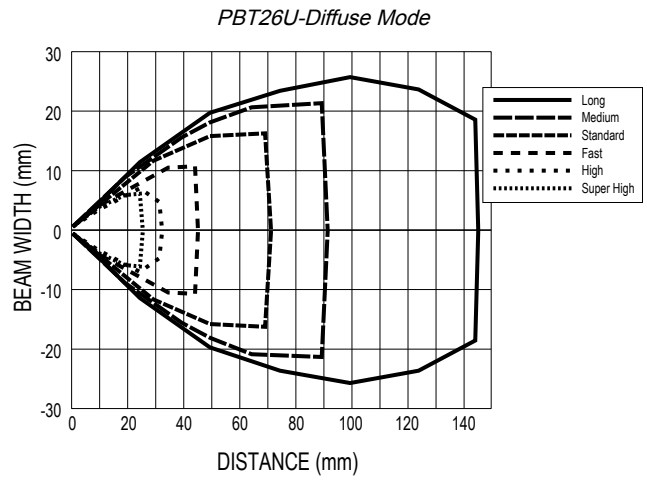
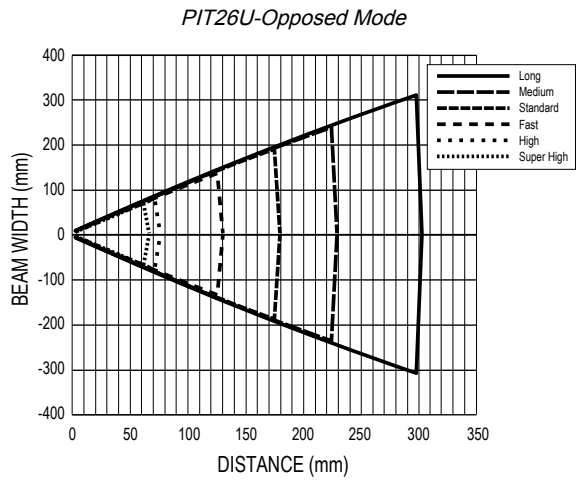
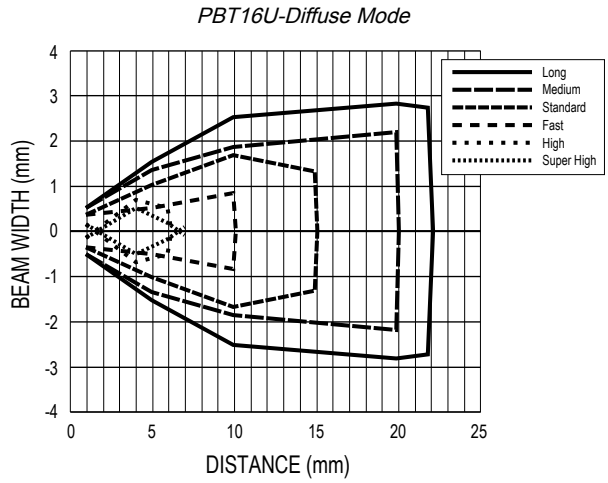
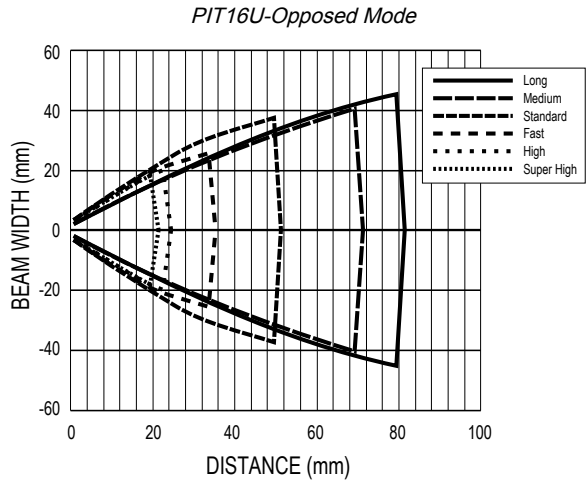

Continued on page 9

Continued from page 9

PIT66U-Opposed Mode

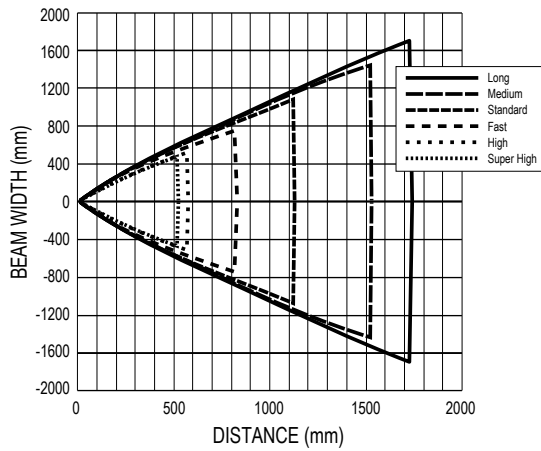

PBT66U-Diffuse Mode

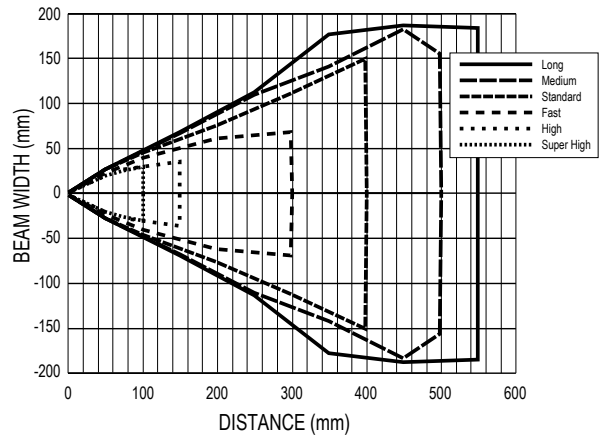

IR850-Opposed Mode

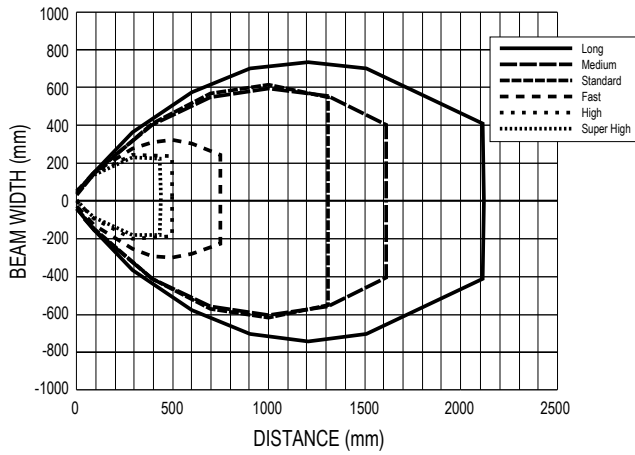

IR850-Diffuse Mode

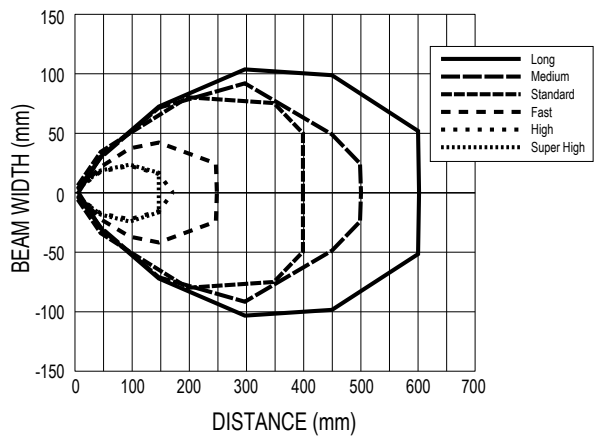

NOTE: IT.83.3ST5M6 glass fiber used for opposed mode

NOTE: BTC1.13.4ST5M6 glass fiber used for diffuse mode

Dimensions

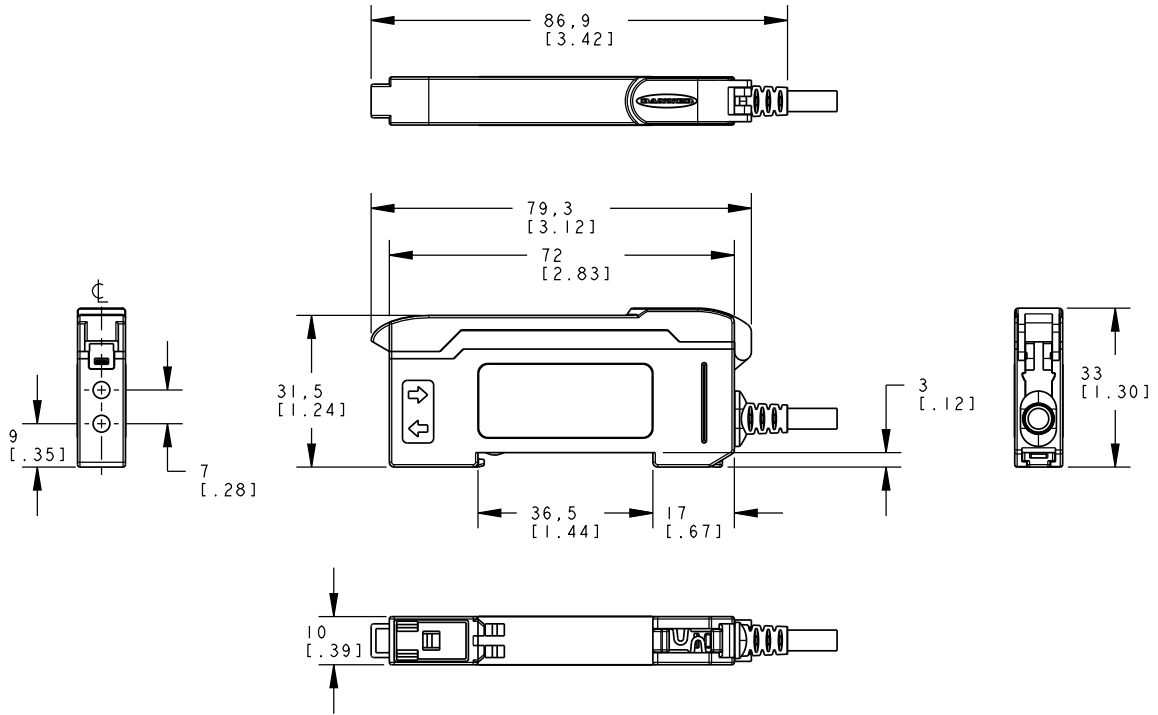

Chapter Contents

Mounting Instructions 12
Mount on a DIN Rail 12
Mount to the Accessory Bracket (SA-DIN-BRACKET) 12
Remove from a DIN rail 12
Installing the Fibers in a DF-Gx Sensor 13
Fiber Adapters 13
Wiring Diagrams 14

Chapter 2 Installation Instructions

Mounting Instructions

Mount on a DIN Rail

1. Hook the DIN rail clip on the bottom of the DF-G2 over the edge of the DIN rail (1).
2. Push the DF-G2 up on the DIN rail (1).
3. Pivot the DF-G2 onto the DIN rail, pressing until it snaps into place (2).

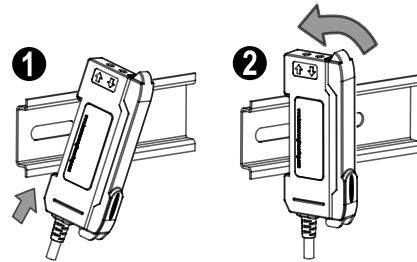

Mount to the Accessory Bracket (SA-DIN-BRACKET)

1. Position the DF-G2 in the SA-DIN-BRACKET.
2. Insert the supplied M3 screws.
3. Tighten the screws.

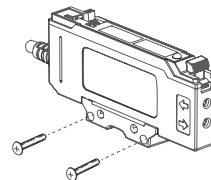

Remove from a DIN rail

1. Push the DF-G2 up on the DIN rail (1).
2. Pivot the DF-G2 away from the DIN rail and remove it (2).

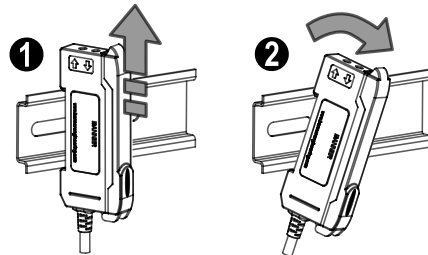

Installing the Fibers in a DF-Gx Sensor

Follow these steps to install glass or plastic fibers.

1. Open the dust cover.
2. Move the fiber clamp forward to unlock it.
3. Insert the fiber(s) into the fiber port(s) until they stop.
4. Move the fiber clamp backward to lock the fiber(s).
5. Close the dust cover.

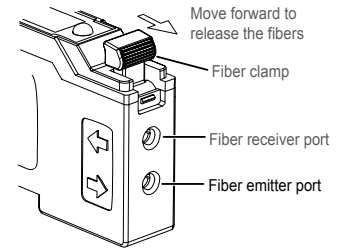

For optimum performance of IR models, if applicable, glass fibers must be used.

Fiber Adapters

If a thin fiber with less than 2.2 mm outer diameter is used, install the fiber adapter provided with the fiber assembly to ensure a reliable fit in the fiber holder. Align the fibers to the end of the adapters. Banner includes the adapters with all fiber assemblies.

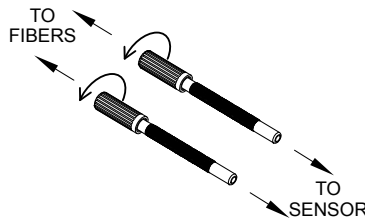

Fiber Outer Diameter (mm)	Adapter Color
Ø 1.0	Black
Ø 1.3	Red
Ø 2.2	No adapter needed

When connecting coaxial-type fiber assemblies to the amplifier, install the single-core (center) fiber to the Transmitter port, and the multi-core (outer) fiber to the Receiver port. This will result in the most reliable detection.

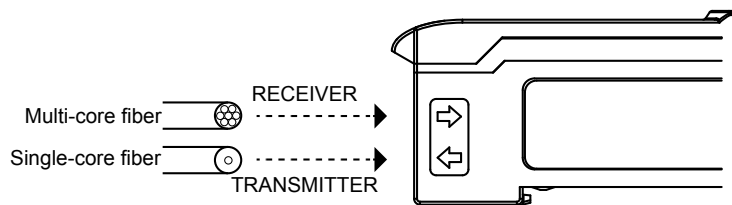

Wiring Diagrams

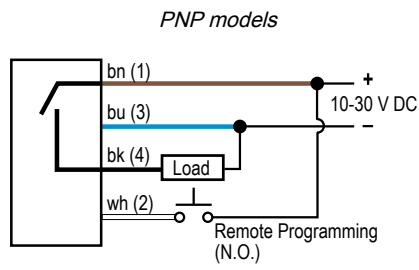
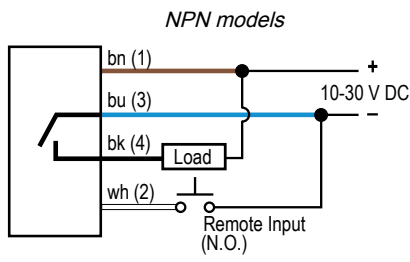

Key

- 1 = Brown
- 2 = White
- 3 = Blue
- 4 = Black

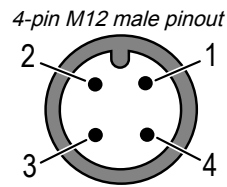
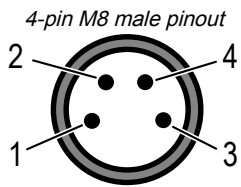

Open lead wires must be connected to a terminal block.

Chapter Contents

Run Mode..... 15
 Program Mode..... 15
 Remote Input..... 18
 Adjust Mode..... 19

Chapter 3 Operating Instructions

Run Mode

Run mode allows the sensor to operate normally and prevents unintentional programming changes. The +/-SET/- rocker button is disabled during RUN mode, except when using Window SET.

Program Mode

Program (PRG) mode allows the following settings to be programmed in the DF-G2 (refer to Program Mode Flowchart and Remote Input Flowchart for programming).

See Factory Default Settings in [Specifications](#).

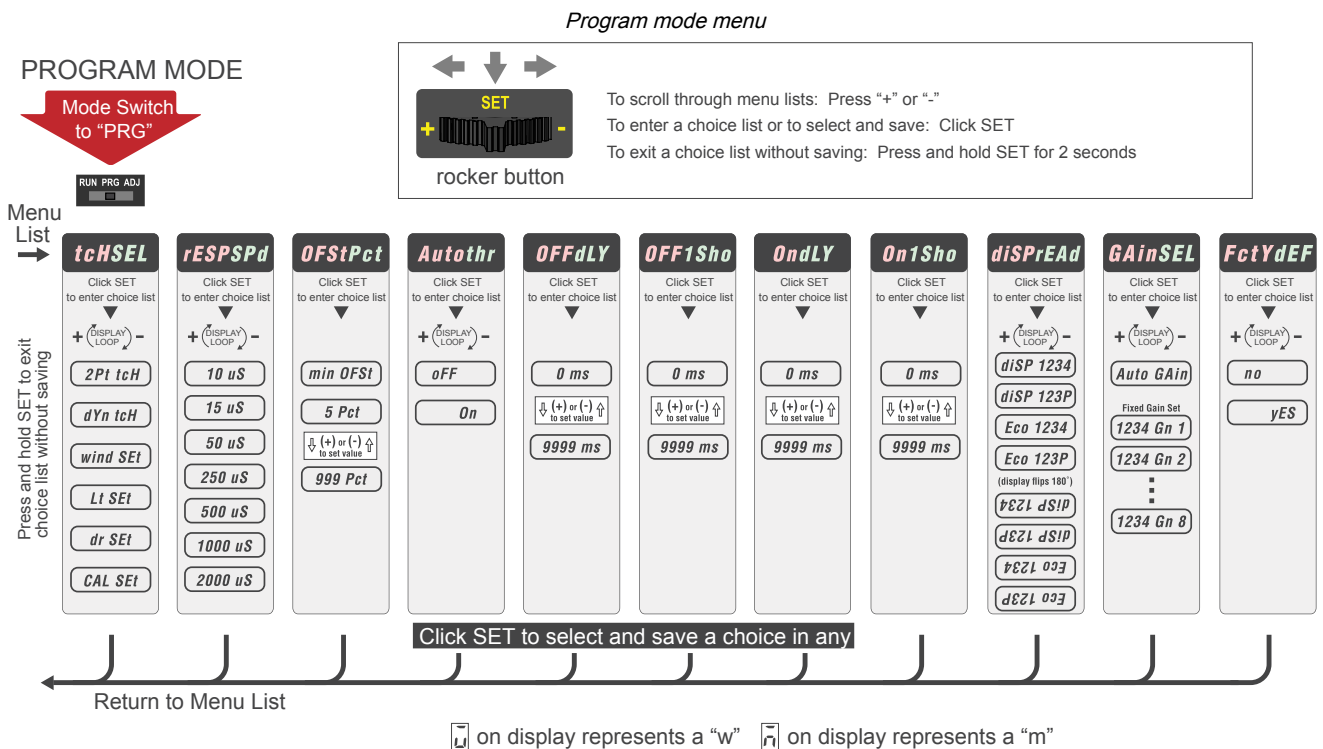

TEACH Selection



The DF-G2 can be programmed for one of the following TEACH/SET methods:

- Two-Point TEACH
- Dynamic TEACH
- Window SET
- Light SET
- Dark SET
- Calibration SET

NOTE: A **TEACH Selection** must be selected by programming before TEACH/SET methods can be used.

Response Speed

RESP SPD

The DF-G2 can be programmed for one of the following Response Speeds:

Response Speed	Display Range	Crosstalk Avoidance Algorithm
10 μ s (Super High Speed)	0 – 4000	Disabled
15 μ s (High Speed)	0 – 4000	Disabled
50 μ s (Fast)	0 – 4000	Disabled
250 μ s (Standard)	0 – 4000	Enabled
500 μ s (Medium Range)	0 – 9999	Enabled
1000 μ s (Long Range)	0 – 9999	Enabled
2000 μ s (Long Range with immunity to Energy Efficient Lights)	0 – 9999	Enabled

Offset Percent

The Offset Percent is used during the Window, Light, or Dark SET methods. The threshold(s) are positioned a programmable % offset from the taught condition.

The allowable range depends upon the Response Speed Mode, as shown below:

Response Speed	MIN %	MAX %
10 μ s	5	999
15 μ s	5	999
50 μ s	2	999
250 μ s	2	999
500 μ s	1	999
1000 μ s	1	999
2000 μ s	1	999

The offset percent can also be programmed to **Minimum Offset**. This allows the DF-G2 to set the threshold(s) as close as possible to the presented condition, but still provide for reliable sensing.

NOTE: Offset Percent **MUST** be programmed to **Minimum Offset** for Dark SET to accept conditions of no signal (0 counts).

Auto Thresholds

Auto THR

Auto Thresholds can be programmed to be ON/OFF. The Auto Thresholds algorithm continuously tracks slow changes in the taught condition(s), and optimizes the threshold(s) to provide for reliable sensing. For Two-Point and Dynamic TEACH, the algorithm optimizes the threshold to be centered between the light and dark conditions. For Window, Light, and Dark SET, the algorithm optimizes the threshold(s) to maintain the programmed Offset Percent from the taught condition.

- After programming Auto Thresholds to ON, it is highly recommended to re-perform the TEACH/SET method
- Manual Adjustments are disabled when Auto Thresholds are ON
- Auto Thresholds are automatically disabled in Calibration SET (see "[Calibration SET](#)" on page 27)
- Severe contamination/changes in the taught condition can prevent the Auto Thresholds algorithm from optimizing the threshold(s). If this occurs, the DF-G2 enters a **Threshold Alert** or **Threshold Error** state. See "[Troubleshooting](#)" on page 32 for more explanation.

Delays/Timers

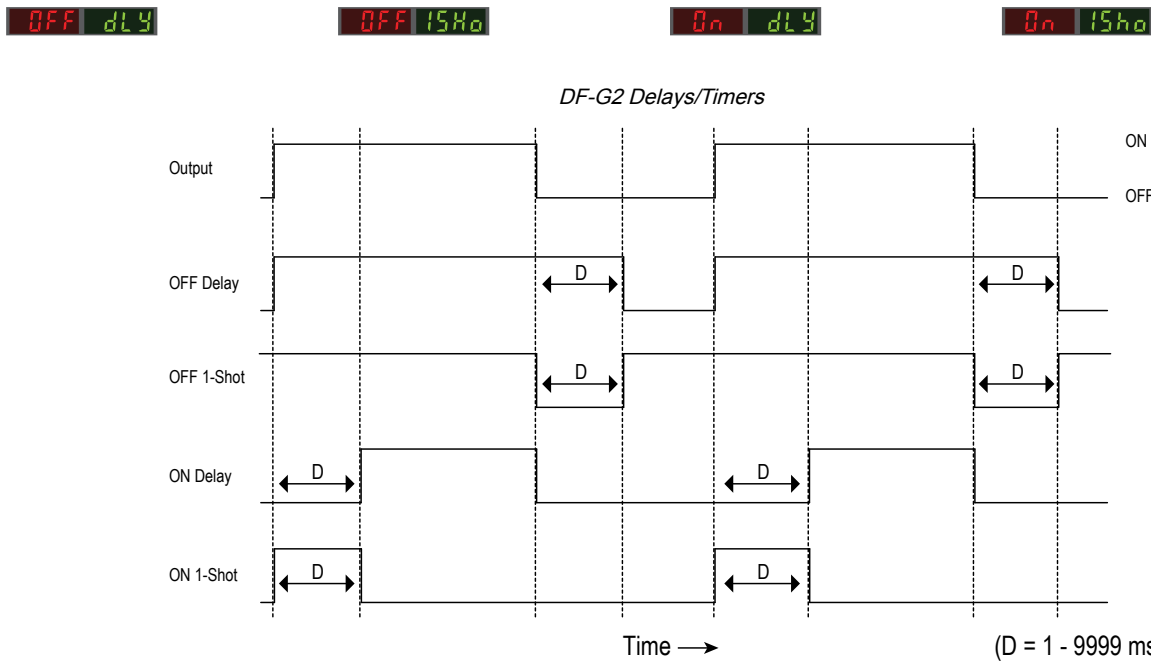

ON/OFF Delays and ON/OFF One-Shot timers can be programmed between 1 - 9999 ms (a value of 0 disables the delay/timer). "Figure: DF-G2 Delays/Timers " on page 17 defines how the delays/timers affect the output behavior.

Some combinations of delays/timers are not allowed. The DF-G2 programming menu automatically disables invalid combinations of delays/timers.

The following table shows the allowable combinations of delays/timers:

	OFF Delay	OFF One-Shot Timer	ON Delay	ON One-Shot Timer
OFF Delay	-	OK	OK	N/A
OFF One-Shot Timer	OK	-	N/A	N/A
ON Delay	OK	N/A	-	OK
ON One-Shot Timer	N/A	N/A	OK	-

Gain Selection



The DF-G2 can operate in Auto Gain mode or the Gain can be fixed to be in Gain . In Auto Gain, the DF-G2 optimizes the gain during a TEACH/SET method for the presented condition(s). While viewing the fixed gains in the Gain Selection choice list, the DF-G2 will automatically switch to the selected gain and display the measured signal on the Red display. This allows for easy and quick evaluation of the fixed gain mode.

Factory Defaults



The Factory Defaults menu allows the DF-G2 to be easily restored back to original factory default settings (see **Factory Default Settings** in [Specifications](#)).

Display Readout



The readout of the digital displays can be programmed for the following options:

- Signal/Threshold readout - Numeric (1234) or % (123P)
- ECO mode - Enabled or Disabled (ECO mode dims the displays to reduce current consumption)
- Display Orientation - Normal (1234) or Flipped (ƭƷƵ1)

Remote Input

The remote input may be used to perform TEACH/SET methods and to program the sensor remotely. Connect the white input wire of the sensor to ground (0 V DC), with a remote switch connected between them. Pulse the remote input according to the diagram shown in "Figure: Remote Input Flowchart" on page 18. Follow the instructions in the TEACH/SET sections in "Adjust Mode" on page 19 to perform a TEACH/SET method.

The sensor exits TEACH and remote programming modes after a 60-second timeout. Users may exit TEACH and remote programming modes by setting the remote input low for more than 2 seconds. In either case, the sensor returns to Run mode without saving any new settings.

Remote Input Flowchart

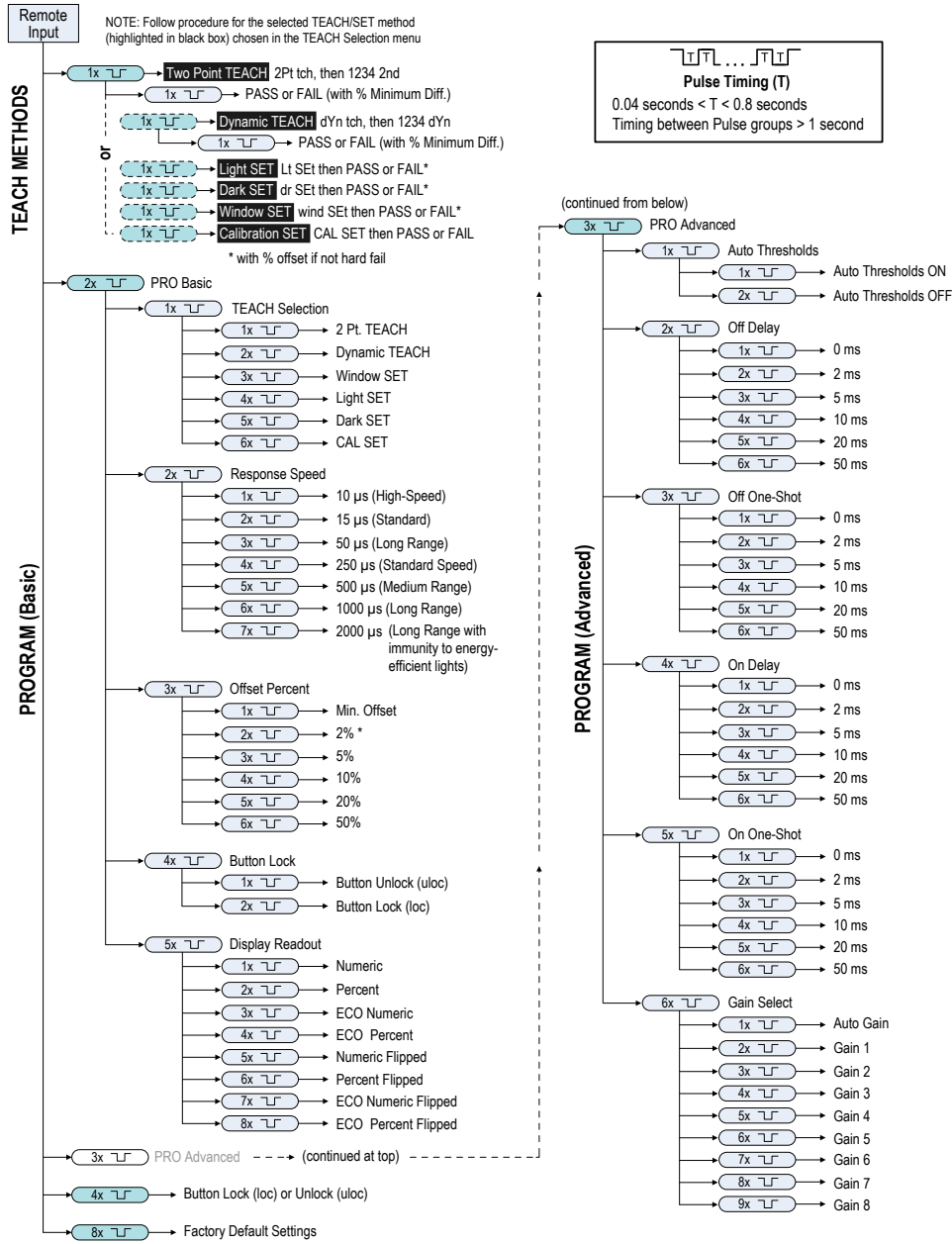

* In Super High-Speed and High-Speed Responses, 2% offset is forced to Min. Offset

Adjust Mode

Sliding the RUN/PRG/ADJ mode switch to the ADJ position allows the user to perform Expert TEACH/SET methods and Manual Adjustment of the threshold(s).

Two-Point TEACH

- Establishes a single switching threshold
- Threshold can be adjusted by using the "+" and "-" rocker button (Manual Adjust)

Two-Point TEACH is used when two conditions can be presented statically to the sensor. The sensor locates a single sensing threshold (the switch point) midway between the two taught conditions, with the Output ON condition on one side, and the Output OFF condition on the other.

Two-Point TEACH (Light Operate shown)

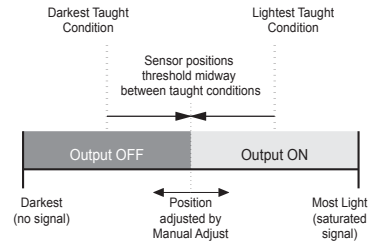

The Output ON and OFF conditions can be reversed by using the LO/DO (Light Operate/ Dark Operate) switch.

Two-Point TEACH and Manual Adjust

Moves the switching threshold value up or down to make adjustments

- Slide Mode switch to ADJ to enter Adjust mode
- Press "+" to increase; press "-" to decrease
 - GREEN display shows the switching threshold value
 - 2 seconds after adjustment, the GREEN display will flash 3 times to confirm
- Slide Mode switch to RUN to complete the operation

REMEMBER: Manual adjustments are disabled when Auto Thresholds are ON

Follow these steps to perform a Two-Point TEACH:

NOTE: TEACH Selection must be programmed to 2Pt tch.

1. Enter Adjust mode.

Method	Action	Result
SET Button ⁽²⁾	Set the Mode switch to ADJ.	Display: Red - Signal Level; Green - Threshold
Remote Input ⁽³⁾	No action is required; the sensor is ready for the Two-Point TEACH method	

2. Teach the first condition.

Method	Action	Result
SET Button	a. Present the first condition. b. Click the SET rocker button.	Display: Flashes "2Pt tch" then holds on "1234 2nd"



Continued on page 20

⁽²⁾ SET Button: 0.04 seconds ≤ "Click" ≤ 0.8 seconds
⁽³⁾ Remote Input: 0.04 seconds ≤ T ≤ 0.8 seconds

Continued from page 19

Method	Action	Result
Remote Input	a. Present the first condition. b. Single-pulse the remote input.	

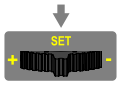
3. Teach the second condition.

Method	Action	Result
SET Button	a. Present the second condition. b. Click the SET rocker button.	
Remote Input	a. Present the second condition. b. Single-pulse the remote input.	<p>TEACH Accepted Displays alternate "PASS" and % Minimum Difference⁽⁴⁾; Sensor returns to Adjust mode</p>  <p>TEACH Not Accepted Displays alternate "FAIL" and % Minimum Difference⁽⁴⁾; Sensor returns to Adjust mode</p> 

4. Return to Run mode.

Method	Action	Result
SET Button	Move the Mode switch to RUN	 Display: Red - Signal Level; Green - Threshold 
Remote Input	No action is required; sensor returns to RUN mode automatically	

Dynamic TEACH

- Teaches on-the-fly
- Establishes a single switching threshold
- Threshold can be adjusted using "+" and "-" rocker button (Manual Adjust)

Dynamic TEACH is best used when a machine or process may not be stopped for teaching. The sensor learns during actual sensing conditions, taking multiple samples of the light and dark conditions and automatically setting the threshold at the optimum level.

The output ON and OFF conditions can be reversed using the LO/DO switch.

Dynamic TEACH (Light Operate shown)

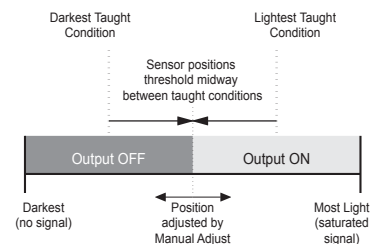

Dynamic TEACH and Manual Adjust

Moves switching threshold value up or down to make adjustments

- Slide Mode switch to ADJ to enter Adjust mode
- Press "+" to increase; press "-" to decrease
 - GREEN display shows the switching threshold value
 - Two seconds after adjustment, GREEN display will flash three times to confirm
- Slide Mode switch to RUN to complete operation

⁽⁴⁾ See "Troubleshooting" on page 32 for more explanation of the % Minimum Difference displayed after the Two-Point TEACH method.

REMEMBER: Manual adjustments are disabled when Auto Thresholds are ON



Follow these steps to perform **Dynamic TEACH**:

NOTE: TEACH Selection must be programmed to **dYn tch**.

1. Enter Adjust Mode.

Method	Action	Result
SET Button ⁽⁵⁾	Set Mode switch to ADJ	Display: Red - Signal Level; Green - Threshold 
Remote Input ⁽⁶⁾	No action is required; the sensor is ready for Dynamic TEACH method	



2. Enter Dynamic TEACH.

Method	Action	Result
SET Button	Click the SET rocker button	Display: Flashes "dYn tch" then holds on "1234 dYn" 
Remote Input	Single-pulse remote input	

3. Present ON and OFF Conditions.

Method	Action	Result
SET Button	Present ON and OFF conditions	Display: Red - Signal Level; Green - Threshold 
Remote Input	Present ON and OFF conditions	

4. Exit Dynamic TEACH.



Method	Action	Result
SET Button	Click the SET rocker button	TEACH Accepted Displays alternate "PASS" with % Minimum Difference ⁽⁷⁾ , Sensor returns to Adjust mode 
Remote Input	Single-pulse remote input	TEACH Not Accepted Displays alternate "FAIL" with % Minimum Difference ⁽⁷⁾ , Sensor returns to Adjust mode 

5. Return to RUN Mode.

⁽⁵⁾ SET Button: 0.04 seconds ≤ "Click" ≤ 0.8 seconds

⁽⁶⁾ Remote Input: 0.04 seconds ≤ T ≤ 0.8 seconds

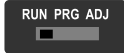
⁽⁷⁾ See "Troubleshooting" on page 32 for more explanation of the % Minimum Difference displayed after the Dynamic TEACH method.

Method	Action		Result
SET Button	Move Mode switch to RUN		Display: Red - Signal Level; Green - Threshold 
Remote Input	No action is required; the sensor returns to RUN mode automatically		

Window SET

- Sets window thresholds that extend a programmable % offset above and below the presented condition
- All other conditions (lighter or darker) cause the output to change state
- Sensing window center can be adjusted using "+" and "-" rocker button (Manual Adjust)
- Recommended for applications where a product may not always appear in the same place, or when other signals may appear
- See Program Mode for programming the Offset Percent setting

Window SET (Light Operate shown)

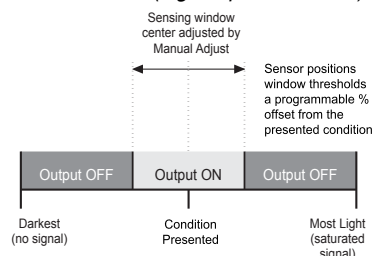

A single sensing condition is presented, and the sensor positions window thresholds a programmable % offset above and below the presented condition. In LO mode, Window SET designates a sensing window with the Output ON condition inside the window, and the Output OFF conditions outside the window.

Output ON and OFF conditions can be reversed using the LO/DO switch.

Window SET and Manual Adjust

Moves sensing window center value up or down to make adjustments

- Slide Mode switch to ADJ to enter Adjust mode
- Press "+" to increase; press "-" to decrease
 - GREEN display shows the sensing window center value
 - Two seconds after adjustment, the GREEN display will flash three times to confirm
- Slide Mode switch to RUN to complete operation

REMEMBER: Manual adjustments are disabled when Auto Thresholds are ON

Follow these steps to perform a Window SET:

NOTE: TEACH Selection must be programmed to **wind SET**.





1. Enter Adjust Mode

Method	Action		Result
SET Button ⁽⁸⁾	Set Mode switch to ADJ		Display: Red - Signal Level; Green - Threshold 
Remote Input ⁽⁹⁾	No action is required; the sensor is ready for Window SET method		

2. SET Sensing Condition

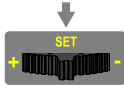
⁽⁸⁾ SET Button: 0.04 seconds ≤ "Click" ≤ 0.8 seconds

⁽⁹⁾ Remote Input: 0.04 seconds ≤ T ≤ 0.8 seconds

Method	Action	Result
SET Button	<ul style="list-style-type: none"> Present sensing condition Click the SET rocker button 	<p>Threshold Condition Accepted Displays read "wind SET" then alternate "PASS" with % Offset⁽¹⁰⁾; Sensor returns to Adjust mode</p> 
Remote Input	<ul style="list-style-type: none"> Present sensing condition Single-pulse the remote input 	<p>Threshold Condition Not Accepted</p> <p>Displays read "wind SET" then alternate "FAIL" with minimum % Offset⁽¹⁰⁾ for sensing condition; Sensor returns to Adjust mode</p> 

3. Return to RUN Mode

Method	Action	Result
SET Button	Move Mode switch to Run	
Remote Input	No action is required; the sensor returns to Run mode automatically	<p>Display: Red - Signal Level; Green - Window Center (see "Figure: Upper and Lower Thresholds" on page 23 for instructions on how to display upper and lower thresholds)</p> 

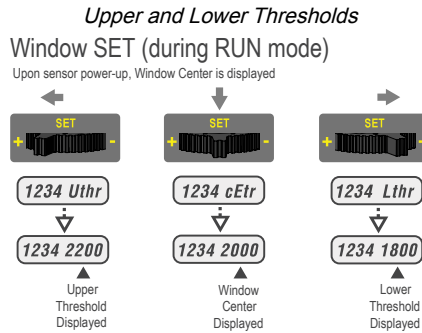

⁽¹⁰⁾ See "Troubleshooting" on page 32 for more explanation of the % Offset displayed after the Window SET method

Light SET

- Sets a threshold a programmable % offset below the presented condition
- Changes output state on any condition darker than the threshold condition
- Threshold can be adjusted using "+" and "-" rocker button (Manual Adjust)
- Recommended for applications where only one condition is known, for example a stable light background with varying darker targets
- See Program Mode for programming the Offset Percent setting

Light SET (Light Operate shown)

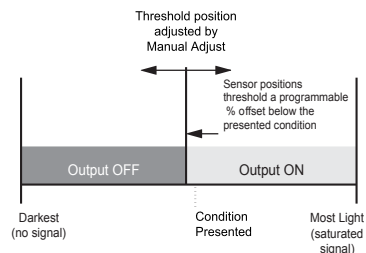

A single sensing condition is presented, and the sensor positions a threshold a programmable % offset below the presented condition. When a condition darker than the threshold is sensed, the output either turns ON or OFF, depending on the LO/DO setting.

Light SET and Manual Adjust

Moves the switching threshold value up or down to make adjustments

- Slide Mode switch to ADJ to enter Adjust mode
- Press "+" to increase; press "-" to decrease
 - GREEN display shows the switching threshold value
 - Two seconds after adjustment, the GREEN display will flash three times to confirm
- Slide Mode switch to RUN to complete operation

REMEMBER: Manual adjustments are disabled when Auto Thresholds are ON

Follow these steps to perform a Light SET:

NOTE: TEACH Selection must be programmed to Lt SET.



1. Enter Adjust Mode

Method	Action	Result
SET Button ⁽¹¹⁾	Set Mode switch to ADJ	Display: Red - Signal Level; Green - Threshold 
Remote Input ⁽¹²⁾	No action is required; the sensor is ready for Light SET method	

2. SET Sensing Condition

⁽¹¹⁾ SET Button: 0.04 seconds ≤ "Click" ≤ 0.8 seconds

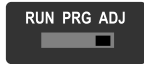
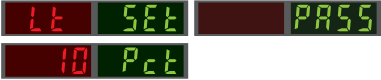
⁽¹²⁾ Remote Input: 0.04 seconds ≤ T ≤ 0.8 seconds

Method	Action	Result
SET Button	<ul style="list-style-type: none"> Present sensing condition Click the SET rocker button 	 <p>Threshold Condition Accepted Displays read "Lt SET" then alternate "PASS" with % Offset⁽¹³⁾; Sensor returns to Adjust mode</p> 
Remote Input	<ul style="list-style-type: none"> Present sensing condition Single-pulse the remote input 	 <p>Threshold Condition Not Accepted</p> <p>Displays read "Lt SET" then alternate "FAIL" with minimum % Offset⁽¹³⁾ for sensing condition; Sensor returns to Adjust mode</p> 

3. Return to RUN Mode

Method	Action	Result
SET Button	Move Mode switch to RUN	 <p>Display: Red - Signal Level; Green - Threshold</p> 
Remote Input	No action is required; the sensor returns to RUN mode automatically	

Dark SET

- Sets a threshold a programmable % offset above the presented condition
- Any condition lighter than the threshold condition causes the output to change state
- Threshold can be adjusted using "+" and "-" rocker button (Manual Adjust)
- Recommended for applications where only one condition is known, for example, a stable dark background with varying lighter targets
- See Program Mode for programming the Offset Percent setting

NOTE: Offset Percent MUST be programmed to **Minimum Offset** to accept conditions of no signal (0 counts).

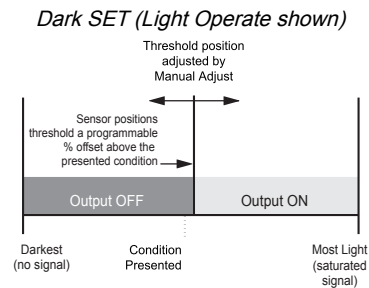

A single sensing condition is presented, and the sensor positions a threshold a programmable % offset above the presented condition. When a condition lighter than the threshold is sensed, the output either turns ON or OFF, depending on the LO/DO setting.

Dark SET and Manual Adjust

Moves the switching threshold value up or down to make adjustments

- Slide Mode switch to ADJ to enter Adjust mode
- Press "+" to increase; press "-" to decrease
 - GREEN display shows the switching threshold value
 - Two seconds after adjustment, the GREEN display will flash three times to confirm

⁽¹³⁾ See "Troubleshooting" on page 32 for more explanation of the % Offset displayed after the Light SET method

- Slide Mode switch to RUN to complete the operation

REMEMBER: Manual adjustments are disabled when Auto Thresholds are ON





Follow these steps to perform a Dark SET:

NOTE: TEACH Selection must be programmed to **dr SET**.

1. Enter Adjust Mode.

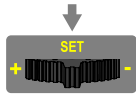
Method	Action	Result
SET Button ⁽¹⁴⁾	Set Mode switch to ADJ	Display: Red - Signal Level; Green - Threshold 
Remote Input ⁽¹⁵⁾	No action is required; the sensor is ready for Dark SET method	

2. SET Sensing Condition.

Method	Action	Result
SET Button	<ul style="list-style-type: none"> ◦ Present sensing condition ◦ Click the SET rocker button 	<p>Threshold Condition Accepted Displays read "dr SET" then alternate "PASS" with % Offset⁽¹⁶⁾; Sensor returns to Adjust mode</p> 
Remote Input	<ul style="list-style-type: none"> ◦ Present sensing condition ◦ Single-pulse the remote input 	<p>Threshold Condition Not Accepted</p> <p>Displays read "dr SET" then alternate "FAIL" with minimum % Offset⁽¹⁶⁾ for sensing condition; Sensor returns to Adjust mode</p> 

3. Return to RUN Mode.

Method	Action	Result
SET Button	Move Mode switch to RUN	Display: Red - Signal Level; Green - Threshold 
Remote Input	No action is required; the sensor returns to RUN mode automatically	

⁽¹⁴⁾ SET Button: 0.04 seconds ≤ "Click" ≤ 0.8 seconds

⁽¹⁵⁾ Remote Input: 0.04 seconds ≤ T ≤ 0.8 seconds

⁽¹⁶⁾ See "Troubleshooting" on page 32 for more explanation of the % Offset displayed after the Dark SET method

Calibration SET

- Sets a threshold exactly at the presented condition
- Threshold can be adjusted using "+" and "-" rocker button (Manual Adjust)

A single sensing condition is presented, and the sensor positions a threshold exactly at the presented condition. When a condition lighter than the threshold is sensed, the output either turns ON or OFF, depending on the LO/DO setting.

Calibration SET (Light Operate shown)

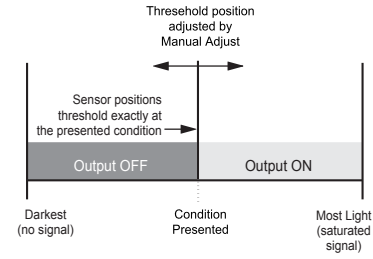

Calibration SET and Manual Adjust

Moves the switching threshold value up or down to make adjustments

- Slide Mode switch to ADJ to enter Adjust mode
- Press "+" to increase; press "-" to decrease
 - GREEN display shows the switching threshold value
 - Two seconds after adjustment, the GREEN display will flash three times to confirm
- Slide Mode switch to RUN to complete the operation

REMEMBER: Auto Thresholding is automatically disabled in Calibration SET

Follow these steps to perform a Calibration SET:

NOTE: TEACH Selection must be programmed to **CAL SET**.

1. Enter Adjust Mode



Method	Action	Result
SET Button ⁽¹⁷⁾	<ul style="list-style-type: none"> ◦ Set Mode switch to ADJ 	
Remote Input ⁽¹⁸⁾	No action is required; the sensor is ready for Calibration SET method	

2. SET Sensing Condition

Method	Action	Result
SET Button	<ul style="list-style-type: none"> ◦ Present sensing condition ◦ Click the SET rocker button 	
Remote Input	<ul style="list-style-type: none"> ◦ Present sensing condition ◦ Single-pulse the remote input 	
		<p>Threshold Condition Unacceptable</p> <p>Displays read "cAL SET" then flashes "FAIL"; Sensor returns to Adjust mode</p>

3. Return to RUN Mode

⁽¹⁷⁾ SET Button: 0.04 seconds ≤ "Click" ≤ 0.8 seconds
⁽¹⁸⁾ Remote Input: 0.04 seconds ≤ T ≤ 0.8 seconds

Method	Action		Result
SET Button	Move Mode switch to RUN		Display: Red - Signal Level; Green - Threshold 
Remote Input	No action is required; the sensor returns to RUN mode automatically		

Chapter Contents

Quick-Disconnect Cordsets 29

Chapter 4 Accessories

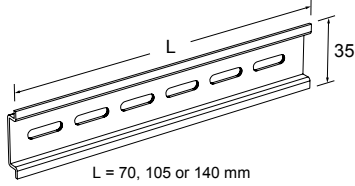
DIN-35-..	Models	Length (mm)
35 mm DIN Rail  <p>L = 70, 105 or 140 mm</p> <p>Hole center spacing: 35.1 Hole size: 25.4 x 5.3</p>	DIN-35-70 CAD Files: DXF , PDF , IGS , STP	70
	DIN-35-105 CAD Files: DXF , PDF , IGS , STP	105
	DIN-35-140 CAD Files: DXF , PDF , IGS , STP	140
	DIN-35-180 CAD Files: DXF , PDF , IGS , STP	180
	DIN-35-220 CAD Files: DXF , PDF , IGS , STP	220

SA-DIN-CLAMP

- Pair of metal DIN rail end stops; slide onto DIN rail at either side of the sensor stack
- Combination (#2 Phillips, #8 standard slotted) set screw

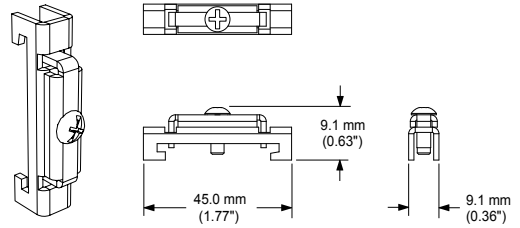

SA-DIN-BRACKET

- Plastic bracket with mounting screws
- CAD Files: [DXF](#), [PDF](#), [IGS](#), [STP](#)

Hole center spacing: A = 16, B = 25.4, C = 15.2
Hole size: A = \varnothing 3.2, B = \varnothing 3.3, C = \varnothing 4.4

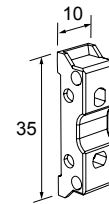

SA-DIN-BRACKET-10

- Package of 10 plastic brackets with mounting screws
- CAD Files: [DXF](#), [PDF](#), [IGS](#), [STP](#)

Hole center spacing: A = 16, B = 25.4, C = 15.2
Hole size: A = \varnothing 3.2, B = \varnothing 3.3, C = \varnothing 4.4

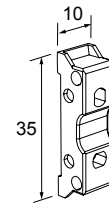

Quick-Disconnect Cordsets

All measurements are listed in millimeters, unless noted otherwise. The measurements provided are subject to change.

4-Pin Single-Ended M12 Female Cordsets					
Model	Length	Style	Dimensions	Pinout (Female)	
MQDC-406	2 m (6.56 ft)	Straight			1 = Brown 2 = White 3 = Blue 4 = Black 5 = Not used
MQDC-415	5 m (16.4 ft)				
MQDC-430	9 m (29.5 ft)				
MQDC-450	15 m (49.2 ft)	Right-Angle			
MQDC-406RA	2 m (6.56 ft)				
MQDC-415RA	5 m (16.4 ft)				
MQDC-430RA	9 m (29.5 ft)				
MQDC-450RA	15 m (49.2 ft)				

4-Pin Single-Ended M8 Female Cordsets					
Model	Length	Style	Dimensions	Pinout (Female)	
PKG4M-2	2 m (6.56 ft)	Straight			1 = Brown 2 = White 3 = Blue 4 = Black
PKG4M-5	5 m (16.4 ft)				
PKG4M-9	9 m (29.52 ft)				
PKW4M-2	2 m (6.56 ft)	Right Angle			
PKW4M-5	5 m (16.4 ft)				
PKW4M-9	9 m (29.5 ft)				

4-Pin Single-Ended Snap-on M8 Female Cordsets					
Model	Length	Style	Dimensions	Pinout (Female)	
PKG4-2	2.03 m (6.66 ft)	Straight			1 = Brown 2 = White 3 = Blue 4 = Black
PKG4-5	5.03 m (16.5 ft)				
PKG4-10	10 m (32.9 ft)				

Continued on page 31

Continued from page 30

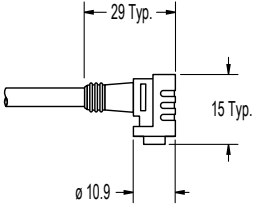
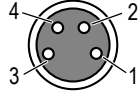
4-Pin Single-Ended Snap-on M8 Female Cordsets				
Model	Length	Style	Dimensions	Pinout (Female)
PKW4Z-2	2 m (6.56 ft)	Right-Angle		
PKW4Z-5	5 m (16.4 ft)			

Chapter Contents

Troubleshooting..... 32
 Banner Engineering Corp Limited Warranty..... 32

Chapter 5 Product Support and Maintenance

Troubleshooting

Manual Adjustments Disabled

Manual adjustments are disabled when Auto Thresholds are ON. If a manual adjustment is attempted while Auto Thresholds are ON, the Green display will flash Auto.

Percent Minimum Difference after TEACH

The Two-Point and Dynamic TEACH methods flash a % minimum difference on the displays after a PASS or FAIL.

Value	PASS/FAIL	Description
0 to 99%	FAIL	The difference between the taught conditions does not meet the required minimum
100 to 300%	PASS	The difference between the taught conditions just meets/exceeds the required minimum; minor sensing variables may affect sensing reliability
300 to 600%	PASS	The difference between the taught conditions sufficiently exceeds the required minimum; minor sensing variables will not affect sensing reliability
600% +	PASS	The difference between the taught conditions greatly exceeds the required minimum, and the operation is very stable operation

Percent Offset after SET

The Window, Dark, and Light SET methods flash a % offset on the displays after a PASS or FAIL.

SET Result	% Offset Meaning
PASS (with % Offset)	Displays the % offset used for the SET method
FAIL (with % Offset)	Displays the minimum required % offset necessary to PASS the SET method
FAIL (without % Offset)	The presented condition cannot be used for the SET method

Threshold Alert or Threshold Error

Severe contamination/changes in the taught condition can prevent the Auto Thresholds algorithm from optimizing the threshold(s).

State	Display	Description	Corrective Action
Threshold Alert	Alternates 	The threshold(s) cannot be optimized, but the sensor's output will still continue to function	Cleaning/correcting the sensing environment and/or a re-teach of the sensor is highly recommended
Threshold Error		The threshold(s) cannot be optimized, and the sensor's output will stop functioning	Cleaning/correcting the sensing environment and/or a re-teach of the sensor is required

Banner Engineering Corp Limited Warranty

Banner Engineering Corp. warrants its products to be free from defects in material and workmanship for one year following the date of shipment. Banner Engineering Corp. will repair or replace, free of charge, any product of its manufacture which, at the time it is returned to the factory, is found to have been defective during the warranty period. This warranty does not cover damage or liability for misuse, abuse, or the improper application or installation of the Banner product.

THIS LIMITED WARRANTY IS EXCLUSIVE AND IN LIEU OF ALL OTHER WARRANTIES WHETHER EXPRESS OR IMPLIED (INCLUDING, WITHOUT LIMITATION, ANY WARRANTY OF MERCHANTABILITY OR FITNESS FOR A PARTICULAR PURPOSE), AND WHETHER ARISING UNDER COURSE OF PERFORMANCE, COURSE OF DEALING OR TRADE USAGE.

This Warranty is exclusive and limited to repair or, at the discretion of Banner Engineering Corp., replacement. **IN NO EVENT SHALL BANNER ENGINEERING CORP. BE LIABLE TO BUYER OR ANY OTHER PERSON OR ENTITY FOR ANY EXTRA COSTS, EXPENSES, LOSSES, LOSS OF PROFITS, OR ANY INCIDENTAL, CONSEQUENTIAL OR SPECIAL DAMAGES RESULTING FROM ANY PRODUCT DEFECT OR FROM THE USE OR INABILITY TO USE THE PRODUCT, WHETHER ARISING IN CONTRACT OR WARRANTY, STATUTE, TORT, STRICT LIABILITY, NEGLIGENCE, OR OTHERWISE.**

Banner Engineering Corp. reserves the right to change, modify or improve the design of the product without assuming any obligations or liabilities relating to any product previously manufactured by Banner Engineering Corp. Any misuse, abuse, or improper application or installation of this product or use of the product for personal protection applications when the product is identified as not intended for such purposes will void the product warranty. Any modifications to this product without prior express approval by Banner Engineering Corp will void the product warranties. All specifications published in this document are subject to change; Banner reserves the right to modify product specifications or update documentation at any time. Specifications and product information in English supersede that which is provided in any other language. For the most recent version of any documentation, refer to: www.bannerengineering.com.

For patent information, see www.bannerengineering.com/patents.

